



(en) Electric current! Danger to life!
Only skilled or instructed persons may carry out the following operations.

(de) Lebensgefahr durch elektrischen Strom!

Nur Elektrofachkräfte und elektrotechnisch unterwiesene Personen dürfen die im Folgenden beschriebenen Arbeiten ausführen.

(fr) Tension électrique dangereuse !

Seules les personnes qualifiées et averties doivent exécuter les travaux ci-après.

(es) ¡Corriente eléctrica! ¡Peligro de muerte!

El trabajo a continuación descrito debe ser realizado por personas cualificadas y advertidas.

(it) Tensione elettrica: Pericolo di morte!

Solo persone abilitate e qualificate possono eseguire le operazioni di seguito riportate.

(zh) 触电危险!

只允许专业人员和受过专业训练的人员进行下列工作。

(ru) Электрический ток! Опасно для жизни!

Только специалисты или проинструктированные лица могут выполнять следующие операции.

(nl) Levensgevaar door elektrische stroom!

Uitsluitend deskundigen in elektriciteit en elektrotechnisch geïnstrueerde personen is het toegestaan, de navolgend beschreven werkzaamheden uit te voeren.

(da) Livsfare på grund af elektrisk strøm!

Kun uddannede el-installatører og personer der er instruerede i elektrotekniske arbejdsopgaver, må udføre de nedenfor anførte arbejder.

(el) Προσοχή, κίνδυνος ηλεκτροπληξίας!

Οι εργασίες που αναφέρονται στη συνέχεια θα πρέπει να εκτελούνται μόνο από ηλεκτρολόγους και ηλεκτροτεχνίτες.

(pt) Perigo de vida devido a corrente eléctrica!

Apenas electricistas e pessoas com formação electotécnica podem executar os trabalhos que a seguir se descrevem.

(sv) Livsfara genom elektrisk ström!

Endast utbildade elektriker och personer som undervisats i elektroteknik får utföra de arbeten som beskrivs nedan.

(fi) Hengenvaarallinen jännite!

Vain pätevät sähköasentajat ja opastusta saaneet henkilöt saavat suorittaa seuraavat työt.

(cs) Nebezpečí úrazu elektrickým proudem!

Níže uvedené práce smějí provádět pouze osoby s elektrotechnickým vzděláním.

(et) Eluohhtlik! Elektrilöögioht!

Järgnevalt kirjeldatud töid tohib teostada ainult elektriala spetsialist või elektrotehnilise instrueerimise läbinud personal.

(hu) Életveszély az elektromos áram révén!

Csak elektromos szakemberek és elektrotechnikában képzett személyek végezhetik el a következőkben leírt munkákat.

(lv) Elektriskā strāva apdraud dzīvību!

Tālāk aprakstītos darbus drīkst veikt tikai elektrospeciālisti un darbam ar elektrotehnikām iekārtām instruetās personas!

(lt) Pavojus gyvybei dėl elektros srovės!

Tik elektrikai ir elektrotechnikos specialistai gali atlikti žemiau aprašytus darbus.

(pl) Porażenie prądem elektrycznym stanowi zagrożenie dla życia!

Opisane poniżej prace mogą przeprowadzać tylko wykwalifikowani elektrycy oraz osoby odpowiednio poinstruowane w zakresie elektrotechniki.

(sl) Življenjska nevarnost zaradi električnega toka!

Spodaj opisana dela smejo izvajati samo elektrostrokovnjaki in elektrotehnično poučene osebe.

(sk) Nebezpečnosť ohrozenia života elektrickým prúdom!

Práce, ktoré sú nižšie opísané, smú vykonávať iba elektroodborníci a osoby s elektrotechnickým vzdelaním.

(bg) Опасност за живота от електрически ток!

Операциите, описани в следващите раздели, могат да се извършват само от специалисти-електротехници и инструктиран електротехнически персонал.

(ro) Atenție! Pericol electric!

Toate lucrările descrise trebuie efectuate numai de personal de specialitate calificat și de persoane cu cunoaștere profundă în electrotehnică.

(hr) Opasnost po život uslijed električne struje!

Radove opisane u nastavku smiju obavljati samo stručni električari i osobe koje su prošle elektrotehničku obuku.

System BE5

BE5

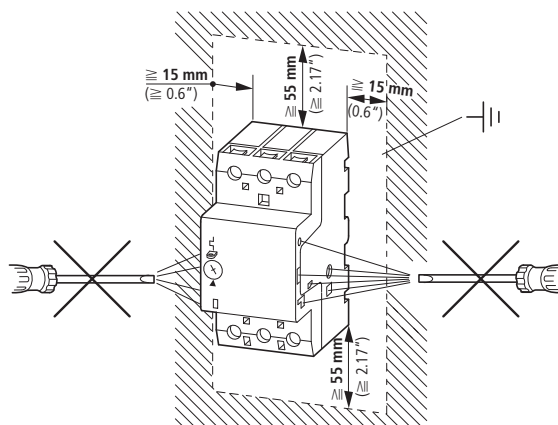
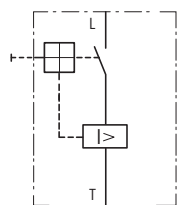
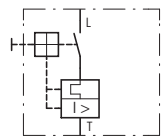

BE5

10 mm (0.39")

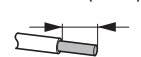

	1 - 6 mm ²	1.7 Nm (15.1 lb-in)
	1 - 4 mm ²	
	1 - 6 mm ²	
DIN46228		
UL	AWG18 - 8 Cu 75 °C	1.8 Nm (16 lb-in) Wire



(en) CAUTION

Manufacturer's instructions for selecting overload and short-circuit protection must be followed.

If an overload or fault current interruption has occurred, current-carrying components or the controller should be examined and replaced if damaged.



(fr) AVERTISSEMENT

Il est impératif de respecter les instructions du fabricant en choisissant les dispositifs de protection contre les surcharges et les court-circuits.

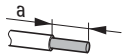

En cas de coupure due à une surcharge ou à un courant de défaut, examiner les éléments porteurs de courant et le contrôleur et les remplacer s'ils sont endommagés.

	a
BE5-U(A)...	9 mm (0.35")
BE5-AGM2	9 mm (0.35")
BE5-NHI11	9 mm (0.35")
BE5-NHI-E-...	6 mm (0.24")



BE5-U(A)...

	1 x (0.75 - 2.5 mm ²) 2 x (0.75 - 2.5 mm ²)	1.2 Nm (10.6 lb-in)
	1 x (0.75 - 2.5 mm ²) 2 x (0.75 - 2.5 mm ²)	AWG18-16

BE5-AGM2, BE5-NHI11

	1 x (0.75 - 1.5 mm ²) 2 x (0.75 - 1.5 mm ²)	1 Nm (8.85 lb-in)
	1 x (0.75 - 1.5 mm ²) 2 x (0.75 - 1.5 mm ²)	AWG18-14

BE5-NHI-E-...

	1 x (0.75 - 1.5 mm ²) 2 x (0.75 - 1.5 mm ²)	1.2 Nm (10.6 lb-in)
	1 x (0.75 - 1.5 mm ²) 2 x (0.75 - 1.5 mm ²)	AWG18-16

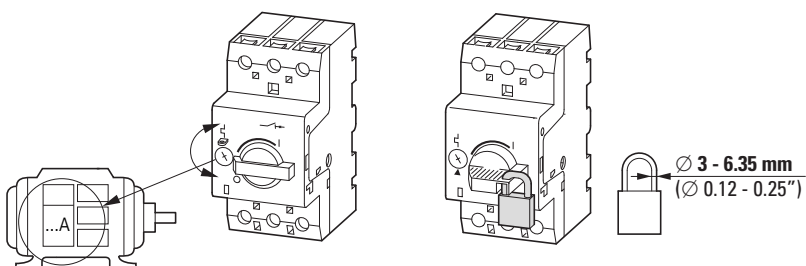
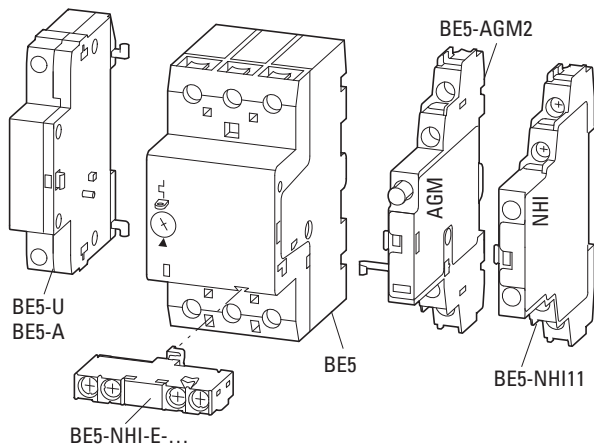

03/19 IL122013ZU

